

Search Progress and Potentially Expanded States in Greedy Best-First Search

Manuel Heusner Thomas Keller Malte Helmert

University of Basel

July 17th, 2018

Motivation

A* [Hart et al.,1968]:

- increasing f -value \rightsquigarrow search progress
- necessarily expanded states \rightsquigarrow quality of heuristic
- potentially expanded states \rightsquigarrow importance of tie-breaking
- never expanded states \rightsquigarrow pruning

Motivation

A* [Hart et al.,1968]:

- increasing f -value \rightsquigarrow search progress
- necessarily expanded states \rightsquigarrow quality of heuristic
- potentially expanded states \rightsquigarrow importance of tie-breaking
- never expanded states \rightsquigarrow pruning

Greedy best-first search [Doran and Michie, 1966]:

- ?

Greedy Best-First Search

- state space search algorithm

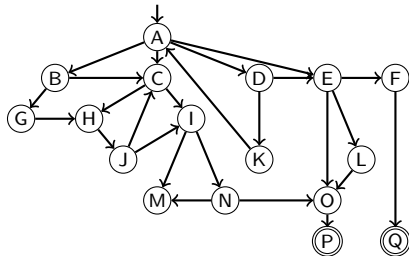

Greedy Best-First Search

- state space search algorithm
- heuristic search algorithm

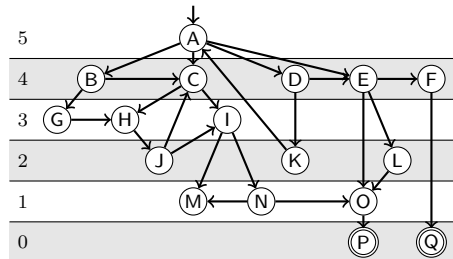

Greedy Best-First Search

- state space search algorithm
- heuristic search algorithm
- greedily expands open states with lowest heuristic value

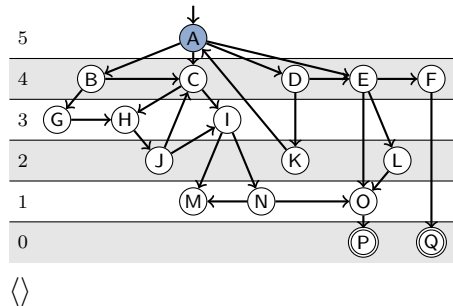

Greedy Best-First Search

- state space search algorithm
- heuristic search algorithm
- greedily expands open states with lowest heuristic value
- tie-breaking decisions

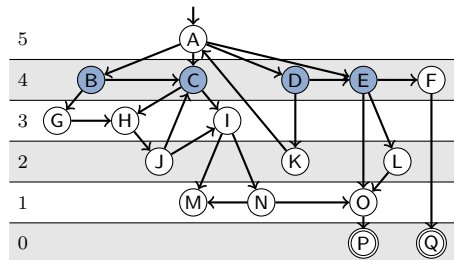

$\langle A \rangle$

Greedy Best-First Search

- state space search algorithm
- heuristic search algorithm
- greedily expands open states with lowest heuristic value
- tie-breaking decisions

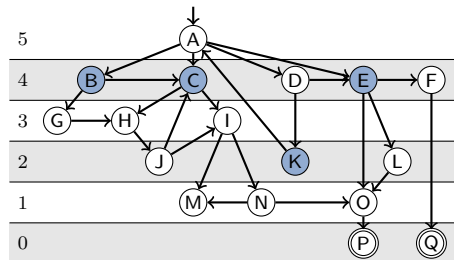

$\langle A, D \rangle$

Greedy Best-First Search

- state space search algorithm
- heuristic search algorithm
- greedily expands open states with lowest heuristic value
- tie-breaking decisions

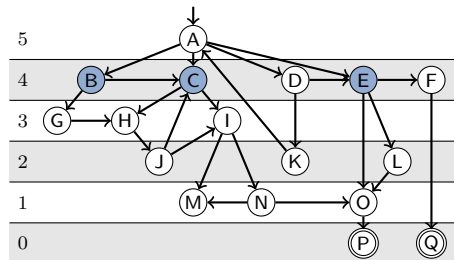

$\langle A, D, K \rangle$

Greedy Best-First Search

- state space search algorithm
- heuristic search algorithm
- greedily expands open states with lowest heuristic value
- tie-breaking decisions

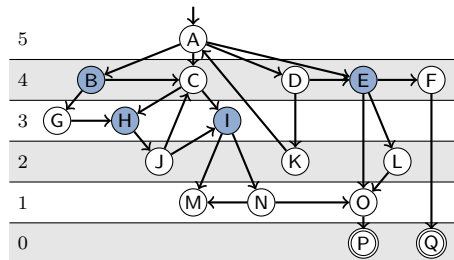

Greedy Best-First Search

- state space search algorithm
- heuristic search algorithm
- greedily expands open states with lowest heuristic value
- tie-breaking decisions

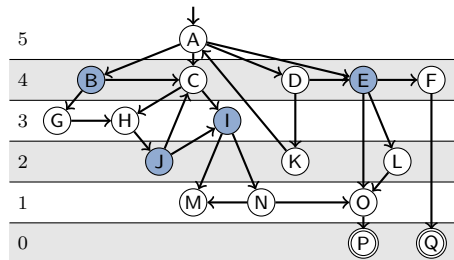

$\langle A, D, K, C, H \rangle$

Greedy Best-First Search

- state space search algorithm
- heuristic search algorithm
- greedily expands open states with lowest heuristic value
- tie-breaking decisions

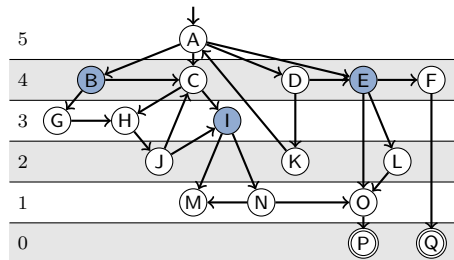

$\langle A, D, K, C, H, J \rangle$

Greedy Best-First Search

- state space search algorithm
- heuristic search algorithm
- greedily expands open states with lowest heuristic value
- tie-breaking decisions

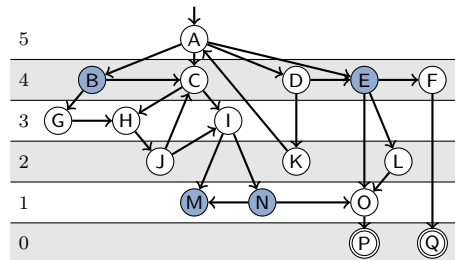

$\langle A, D, K, C, H, J, I \rangle$

Greedy Best-First Search

- state space search algorithm
- heuristic search algorithm
- greedily expands open states with lowest heuristic value
- tie-breaking decisions

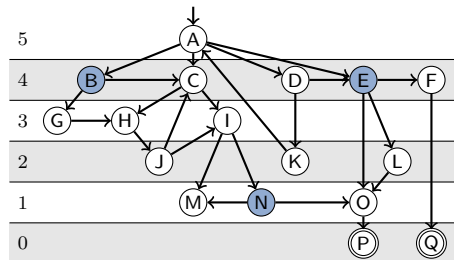

$\langle A, D, K, C, H, J, I, M \rangle$

Greedy Best-First Search

- state space search algorithm
- heuristic search algorithm
- greedily expands open states with lowest heuristic value
- tie-breaking decisions

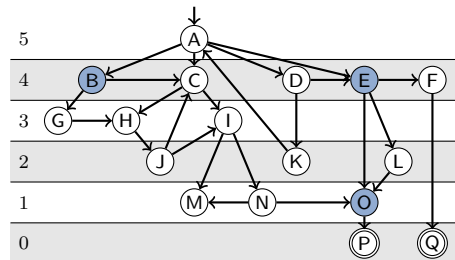

$\langle A, D, K, C, H, J, I, M, N \rangle$

Greedy Best-First Search

- state space search algorithm
- heuristic search algorithm
- greedily expands open states with lowest heuristic value
- tie-breaking decisions

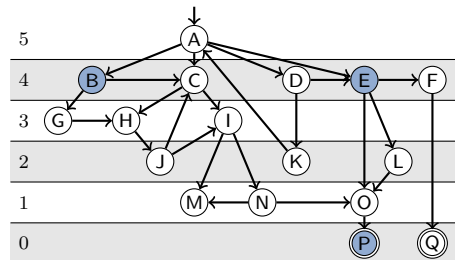

$\langle A, D, K, C, H, J, I, M, N, O \rangle$

Greedy Best-First Search

- state space search algorithm
- heuristic search algorithm
- greedily expands open states with lowest heuristic value
- tie-breaking decisions
- many possible search runs

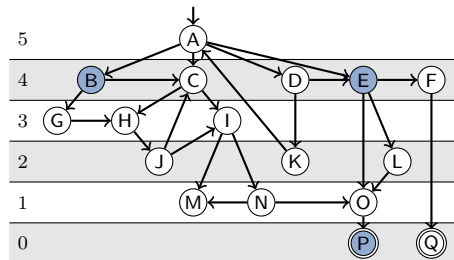

$\langle A, D, K, C, H, J, I, M, N, O \rangle$

$\langle A, B, G, H, J, I, N, O \rangle$

...

$\langle A, E, O \rangle$

High-Water Mark

- basis of our analysis [Wilt & Ruml, 2014]

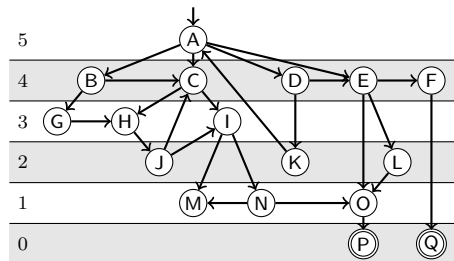

High-Water Mark

- basis of our analysis [Wilt & Ruml, 2014]
- highest heuristic value that GBFS starting in a state must expand in order to reach a goal

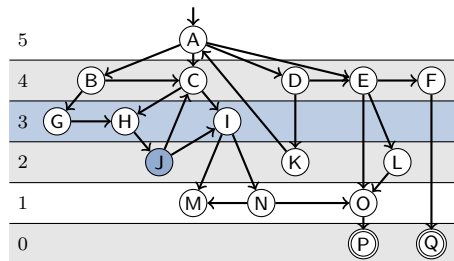

High-Water Mark

- basis of our analysis [Wilt & Ruml, 2014]
- highest heuristic value that GBFS starting in a state must expand in order to reach a goal
- no expansions of states with heuristic values above the high-water mark

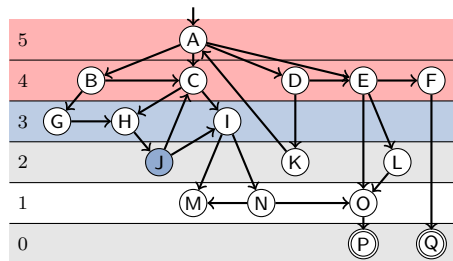

High-Water Mark

- basis of our analysis [Wilt & Ruml, 2014]
- highest heuristic value that GBFS starting in a state must expand in order to reach a goal
- no expansions of states with heuristic values above the high-water mark
- generalize to set of states because GBFS acts **globally**

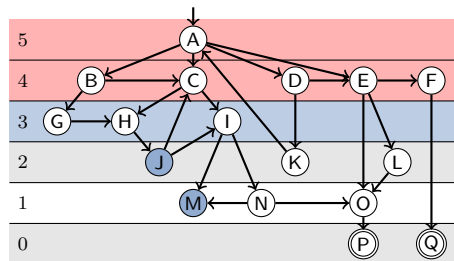

Search Progress

- high-water mark **decreases** during search

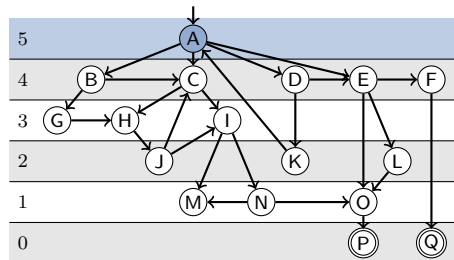

Search Progress

- high-water mark **decreases** during search

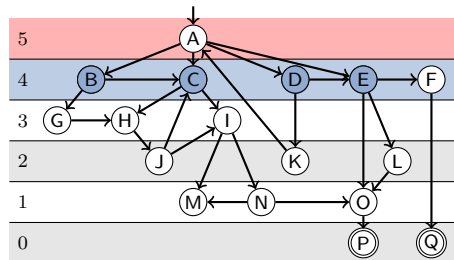

Search Progress

- high-water mark **decreases** during search

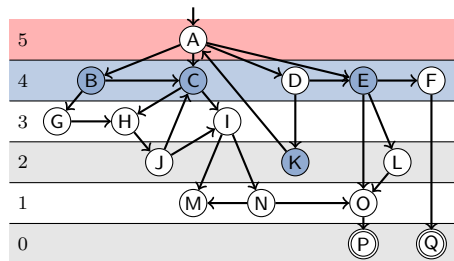

Search Progress

- high-water mark **decreases** during search

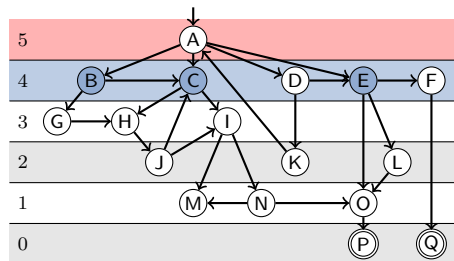

Search Progress

- high-water mark **decreases** during search
- **discard** open states when high-water mark decreases

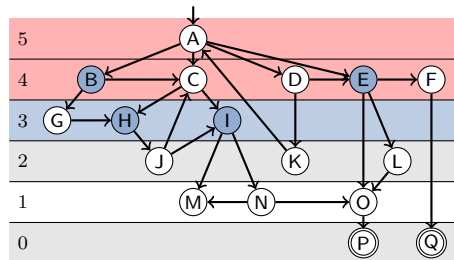

Search Progress

- high-water mark **decreases** during search
- **discard** open states when high-water mark decreases

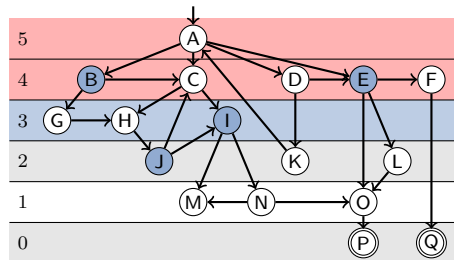

Search Progress

- high-water mark **decreases** during search
- **discard** open states when high-water mark decreases

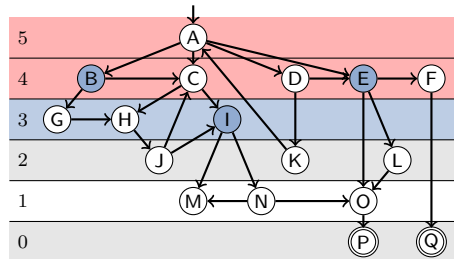

Search Progress

- high-water mark **decreases** during search
- **discard** open states when high-water mark decreases
- **progress** determined **locally**

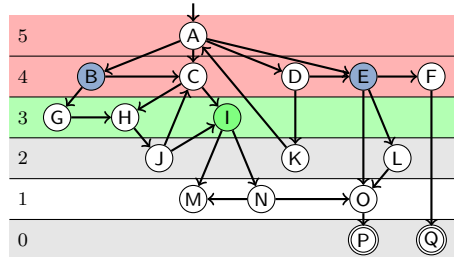

Search Progress

- high-water mark **decreases** during search
- **discard** open states when high-water mark decreases
- **progress** determined **locally**
- expansion of **progress state** generates states with lower high-water mark than that of progress state itself

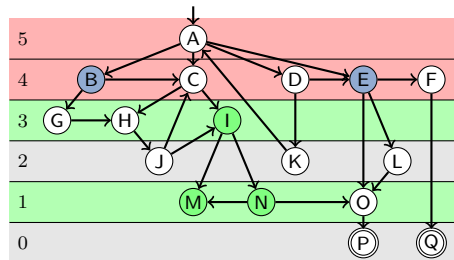

Search Progress

- high-water mark **decreases** during search
- **discard** open states when high-water mark decreases
- **progress** determined **locally**
- expansion of **progress state** generates states with lower high-water mark than that of progress state itself

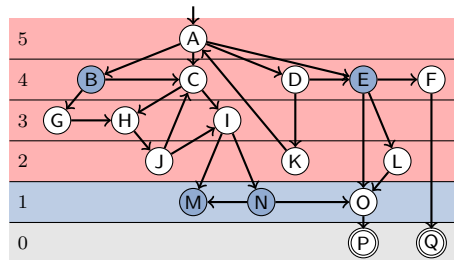

Search Progress

- high-water mark **decreases** during search
- **discard** open states when high-water mark decreases
- **progress** determined **locally**
- expansion of **progress state** generates states with lower high-water mark than that of progress state itself

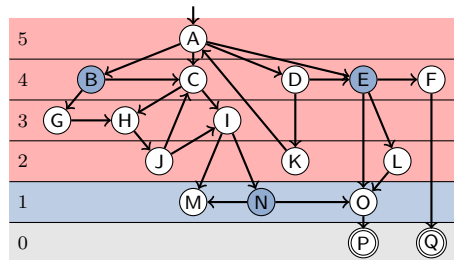

Search Progress

- high-water mark **decreases** during search
- **discard** open states when high-water mark decreases
- **progress** determined **locally**
- expansion of **progress state** generates states with lower high-water mark than that of progress state itself

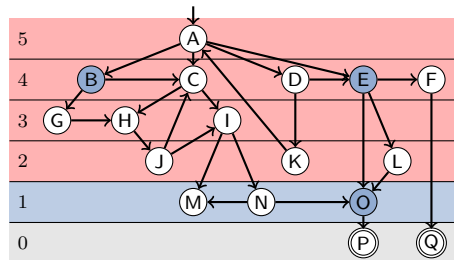

Search Progress

- high-water mark **decreases** during search
- **discard** open states when high-water mark decreases
- **progress** determined **locally**
- expansion of **progress state** generates states with lower high-water mark than that of progress state itself

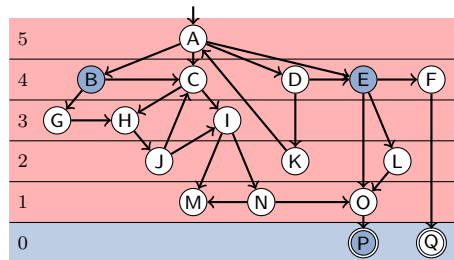

Search Progress

- high-water mark **decreases** during search
- **discard** open states when high-water mark decreases
- **progress** determined **locally**
- expansion of **progress state** generates states with lower high-water mark than that of progress state itself
- possible progress states characterized independent of **tie-breaking** and **search history**

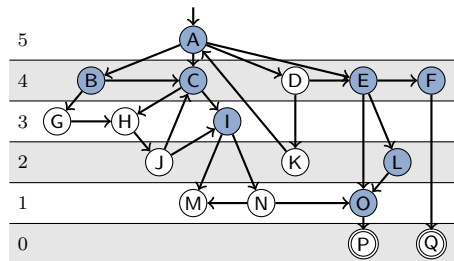

Search Behavior

- progress decomposes state space into a **directed acyclic graph** of **benches**
- benches are **regions** of the state space

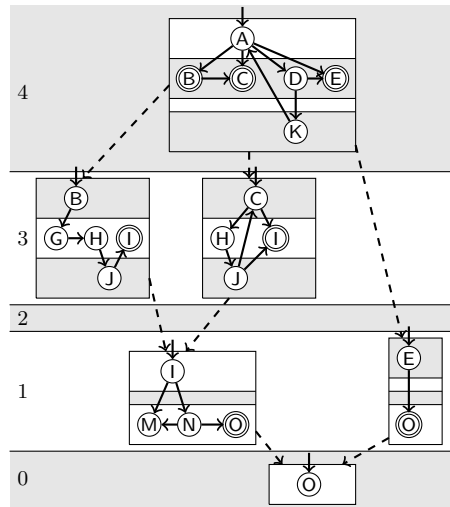

Search Behavior

- progress decomposes state space into a **directed acyclic graph** of **benches**
- benches are **regions** of the state space
- progress splits search run into sequence of **episodes**
- episode is a search a bench

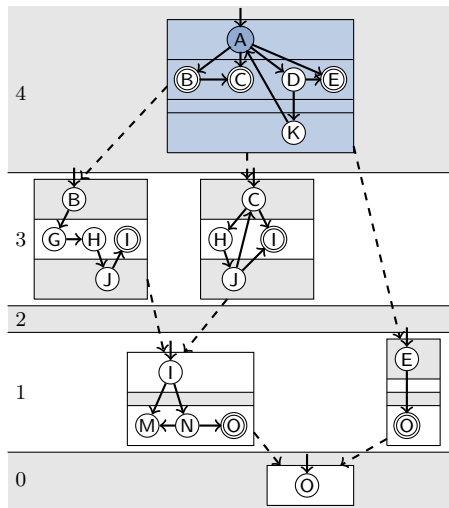

Search Behavior

- progress decomposes state space into a **directed acyclic graph** of **benches**
- benches are **regions** of the state space
- progress splits search run into sequence of **episodes**
- episode is a search a bench

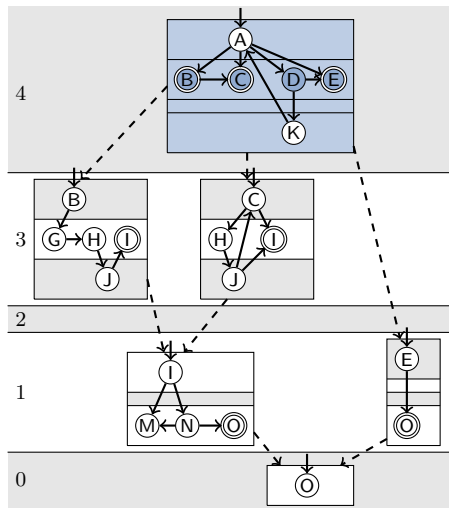

Search Behavior

- progress decomposes state space into a **directed acyclic graph** of **benches**
- benches are **regions** of the state space
- progress splits search run into sequence of **episodes**
- episode is a search a bench

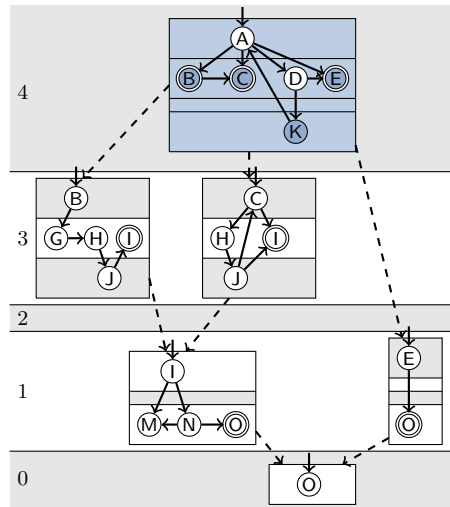

Search Behavior

- progress decomposes state space into a **directed acyclic graph** of **benches**
- benches are **regions** of the state space
- progress splits search run into sequence of **episodes**
- episode is a search a bench

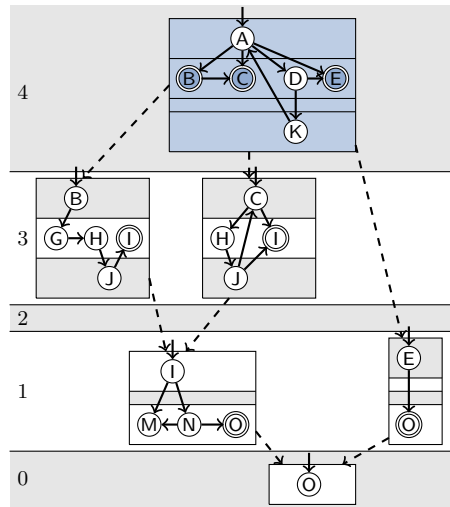

Search Behavior

- progress decomposes state space into a **directed acyclic graph** of **benches**
- benches are **regions** of the state space
- progress splits search run into sequence of **episodes**
- episode is a search a bench
- **transition** to next bench shows progress

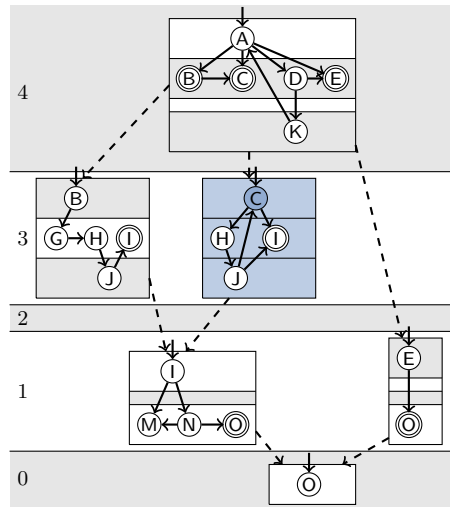

Search Behavior

- progress decomposes state space into a **directed acyclic graph** of **benches**
- benches are **regions** of the state space
- progress splits search run into sequence of **episodes**
- episode is a search a bench
- **transition** to next bench shows progress

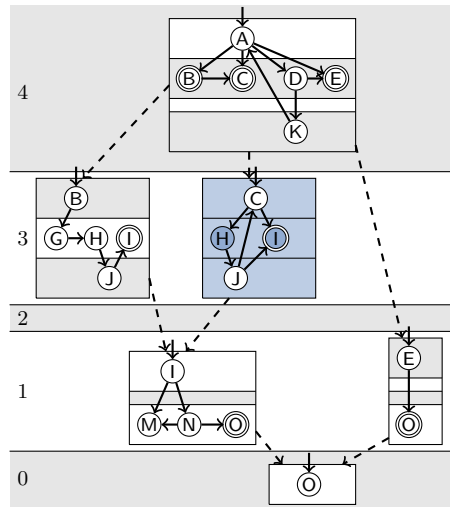

Search Behavior

- progress decomposes state space into a **directed acyclic graph** of **benches**
- benches are **regions** of the state space
- progress splits search run into sequence of **episodes**
- episode is a search a bench
- **transition** to next bench shows progress

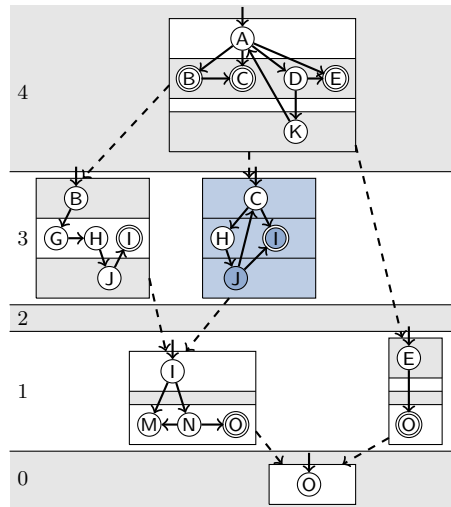

Search Behavior

- progress decomposes state space into a **directed acyclic graph** of **benches**
- benches are **regions** of the state space
- progress splits search run into sequence of **episodes**
- episode is a search a bench
- **transition** to next bench shows progress

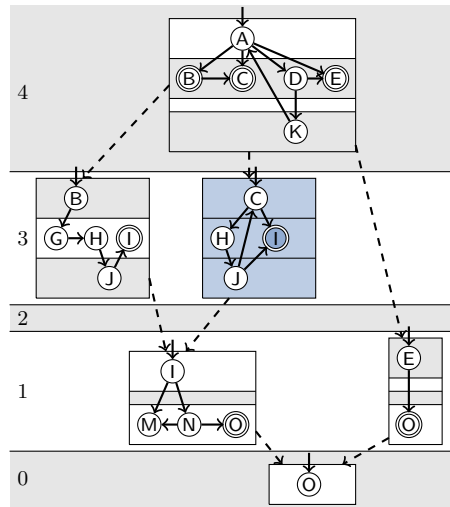

Search Behavior

- progress decomposes state space into a **directed acyclic graph** of **benches**
- benches are **regions** of the state space
- progress splits search run into sequence of **episodes**
- episode is a search a bench
- **transition** to next bench shows progress

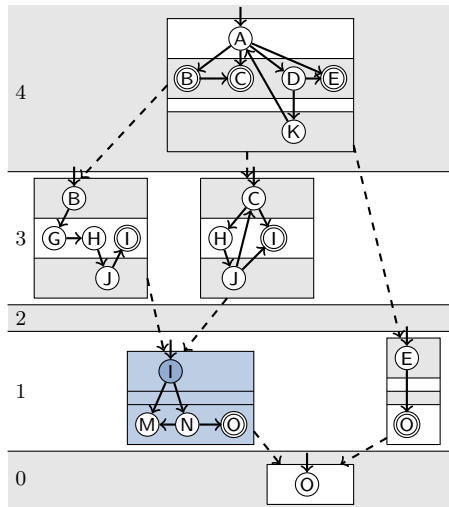

Search Behavior

- progress decomposes state space into a **directed acyclic graph** of **benches**
- benches are **regions** of the state space
- progress splits search run into sequence of **episodes**
- episode is a search a bench
- **transition** to next bench shows progress

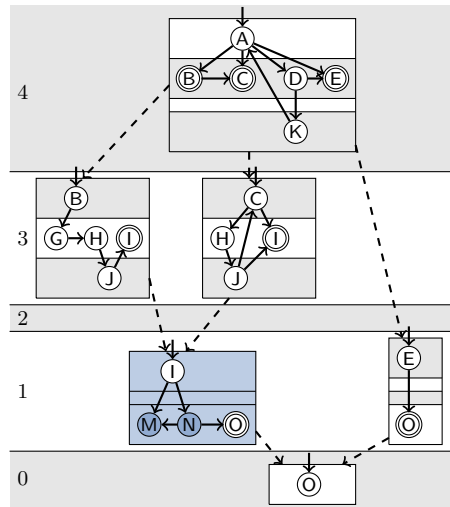

Search Behavior

- progress decomposes state space into a **directed acyclic graph** of **benches**
- benches are **regions** of the state space
- progress splits search run into sequence of **episodes**
- episode is a search a bench
- **transition** to next bench shows progress

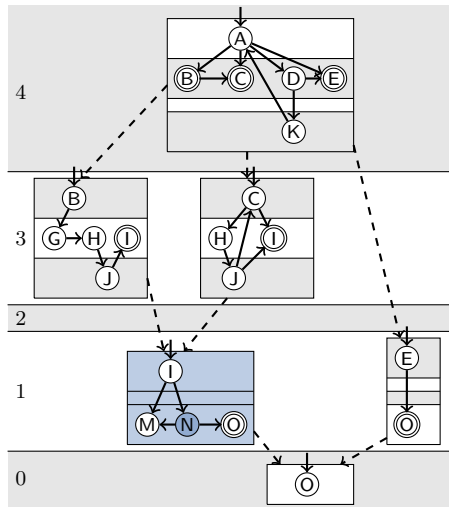

Search Behavior

- progress decomposes state space into a **directed acyclic graph** of **benches**
- benches are **regions** of the state space
- progress splits search run into sequence of **episodes**
- episode is a search a bench
- **transition** to next bench shows progress

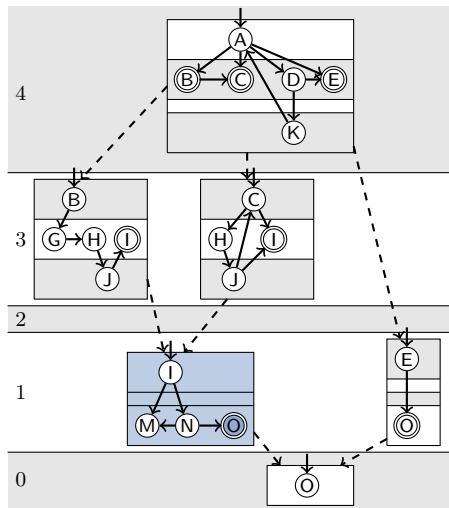

Search Behavior

- progress decomposes state space into a **directed acyclic graph** of **benches**
- benches are **regions** of the state space
- progress splits search run into sequence of **episodes**
- episode is a search a bench
- **transition** to next bench shows progress

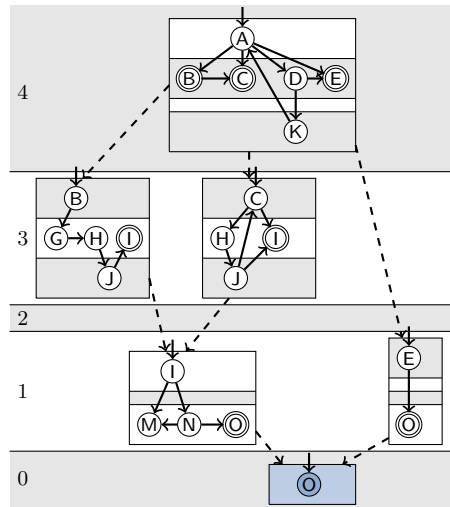

Search Behavior

- progress decomposes state space into a **directed acyclic graph** of **benches**
- benches are **regions** of the state space
- progress splits search run into sequence of **episodes**
- episode is a search a bench
- **transition** to next bench shows progress

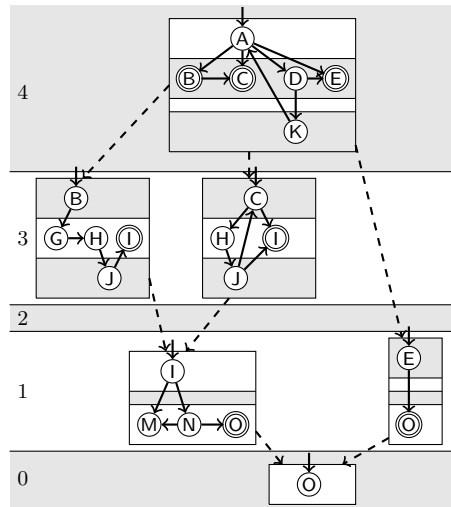

Potentially Expanded States

- states on benches

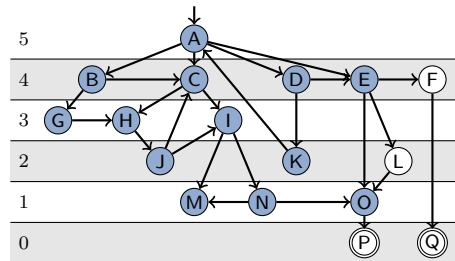

Potentially Expanded States

- states on benches
- states expanded under **any** tie-breaking

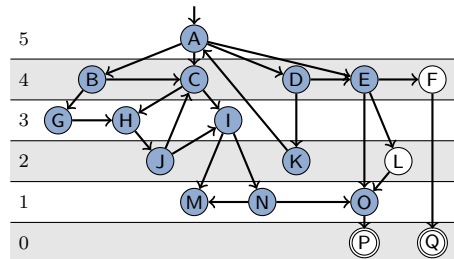

Potentially Expanded States

- states on benches
- states expanded under **any tie-breaking**
- tie-breaking independent **number** for given state space and heuristic

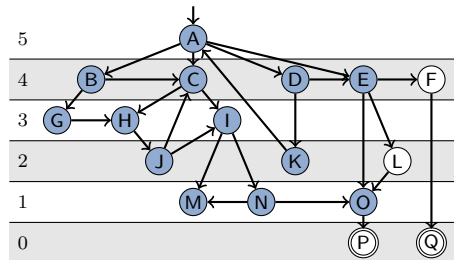

Potentially Expanded States

- states on benches
- states expanded under **any tie-breaking**
- tie-breaking independent **number** for given state space and heuristic
- **never** expanded states

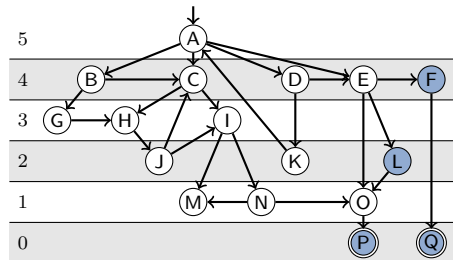

Conclusion

Conclusion:

- surprising local property of progress
- critical role in the search behavior
- reasoning over all possible tie-breakings/search runs

Conclusion

Conclusion:

- surprising local property of progress
- critical role in the search behavior
- reasoning over all possible tie-breakings/search runs

Follow up work:

- Best-Case and Worst-Case Behavior of Greedy Best-First Search
- talk + poster here at [IJCAI2018](#)

Conclusion

Conclusion:

- surprising local property of progress
- critical role in the search behavior
- reasoning over all possible tie-breakings/search runs

Follow up work:

- Best-Case and Worst-Case Behavior of Greedy Best-First Search
- talk + poster here at [IJCAI2018](#)

Thank you for your attention!